

MA-600HIII
SPACE CENTER
Horizontal Machining Center



MA-600HIII

SPACE CENTER

Horizontal Machining Center



A horizontal machining center that delivers outstanding productivity capacity, from overwhelming machining capacity and incredible reliability

Further increase in machining capacity with a powerful new spindle: 10,000 min⁻¹ (option)

- 10,000 min⁻¹ No. 50 spindle machining capacity: 1,240 cm³/min (S45C)
1,496 cm³/min (FCD450)

Higher floor space productivity with larger work envelope

- X-axis travel: 1,050 mm (longer than previous machine)
- Max load workpiece size: ø1,050 × 1,200 mm* (larger than previous machine)
* 2-pallet APC only

Outstanding dimensional stability even for long-run machining of large workpieces

- The Thermo-Friendly Concept minimizes dimensional changes due to ambient temperature changes and machining heat.
Achieves outstanding dimensional stability even during long-run machining.

Productivity improved by shortening non-cutting times

- Shorter tool change times are possible when using thru-spindle coolant, and non-cutting times are also shortened by faster table indexing.

Chip discharge that maximizes uptime

- Effective workspace area washing suppresses chip accumulation and reduces frequent chip cleaning inside the machine.

“Sludgeless Tank” enhances stable operations (recommended option)

- The Sludgeless Tank removes coolant impurities (sludge) that affect machining effectiveness—drastically reducing troublesome tank cleaning.

Automation support to further improve productivity

- Flexible support for automation; multi-pallet APC systems
effective hydraulic/pneumatic fixture port arrangements

Further increase in machining capacity with a powerful new spindle: 10,000 min⁻¹ (option)

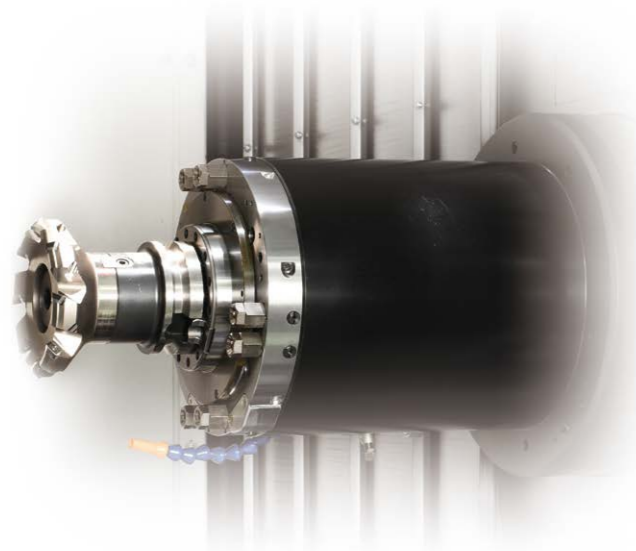

Handling a wide range of applications from heavy-duty to high-feed machining 10,000 min⁻¹ No. 50 (option) Spindle machining capacity

Milling capacity

1,240 cm³/min
(S45C)

Tool: ø160 mm face mill
16 blades (carbide)
Spindle speed: 597 min⁻¹
Cutting Speed: 300 m/min
Feed rates: 3,820 mm/min
Cut width × depth: 112 mm × 2.9 mm
(Cut position: 728 mm from pallet top)

End milling capacity

642 cm³/min
(S45C)

Tool: ø50 mm end mill
4 blades (carbide)
Spindle speed: 1,337 min⁻¹
Cutting Speed: 210 m/min
Feed rates: 1,604 mm/min
Cut width × depth: 10 mm × 40 mm
(Cut position: 762 mm from pallet top)

Milling capacity

1,496 cm³/min
(FCD450)

Tool: ø160 mm face mill
16 blades (carbide)
Spindle speed: 497 min⁻¹
Cutting Speed: 250 m/min
Feed rates: 3,180 mm/min
Cut width × depth: 112 mm × 4.2 mm
(Cut position: 760 mm from pallet top)

End milling capacity

1,031 cm³/min
(FCD450)

Tool: ø80 mm end mill
4 blades (carbide)
Spindle speed: 895 min⁻¹
Cutting Speed: 225 m/min
Feed rates: 1,074 mm/min
Cut width × depth: 16 mm × 60 mm
(Cut position: 577 mm from pallet top)

Note: The "actual data" referred to above for this brochure represent examples, and may not be obtained due to differences in specifications, tooling, cutting condition, and others.

Spindle structure designed for powerful machining

Roller bearings for the front make the spindle extremely rigid. That enables full-potential tooling applications and solid support for powerful cutting.

[Applied spindles]

- Powerful new spindle: 10,000 min⁻¹ No. 50
- Standard spindle: 6,000 min⁻¹ No. 50
- High-torque spindle: 6,000 min⁻¹ No. 50

Long service life provided by all spindles equipped with oil-air lubrication systems

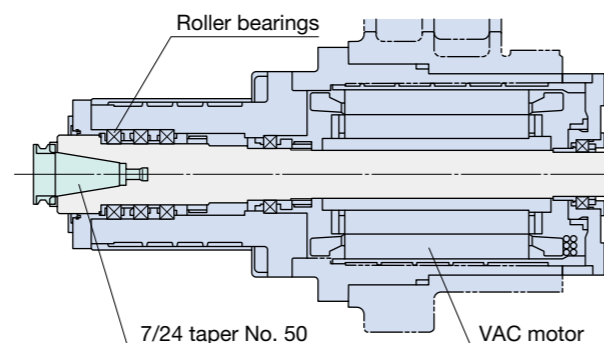

Supporting a wider range of applications with a new spindle lineup

Delivering high machining capacity across a wide range of low to high speeds. Effectively handles a wide range of workpieces from heavy-duty cutting of steel to aluminum machining.

Lineup with powerful new spindle: 10,000 min⁻¹ No. 50 (option)

- Spindle speed: 10,000 min⁻¹
- Max output: 45/30 kW (20 min, 60% ED/cont)
- Max torque: 652/349 N-m (15% ED/cont)

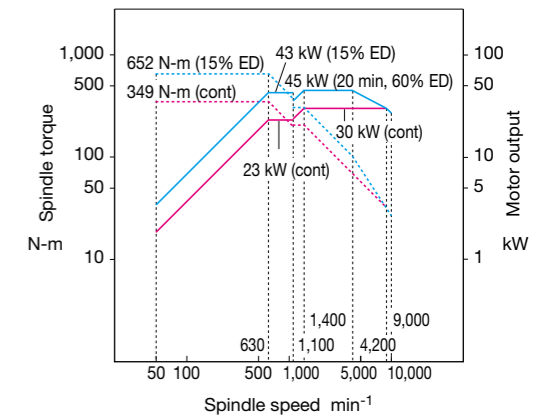

Spindle variations

Mainly for steel workpieces

Standard spindle No. 50

- Spindle speed: 6,000 min⁻¹
- Max output: 30/22 kW (10 min/cont)
- Max torque: 606/349 N-m (10 min/cont)

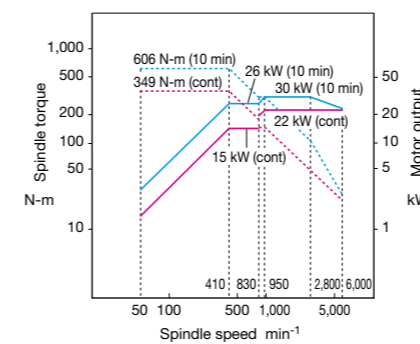

Machines materials from aluminum to steel

Wide-range spindle No. 50 (option)

Max output: 45 kW

(1.2 times more than previous model)

- Spindle speed: 12,000 min⁻¹
- Max output: 45/30 kW (10 min, 25% ED/cont)
- Max torque: 419/194 N-m (2 min/cont)

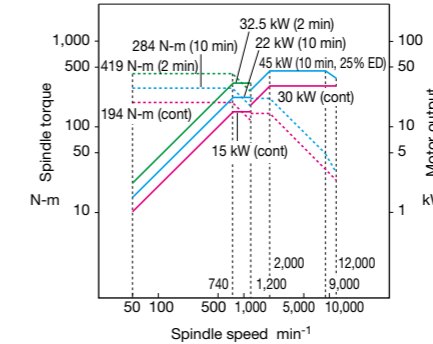

Machines inconel, titanium and other difficult-to-cut materials

High-torque spindle No. 50 (option)

1,071 N-m (heavy-duty cutting)

- Spindle speed: 6,000 min⁻¹
- Max output: 45/37 kW (20 min/cont)
- Max torque: 1,071/637 N-m (3 min/cont)

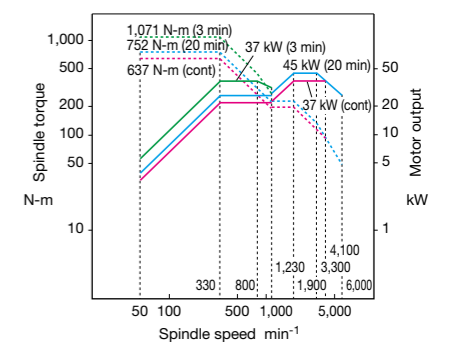

Steel machining

Wide-range spindle No. 40 (option)

- Spindle speed: 15,000 min⁻¹
- Max output: 26/18.5 kW (10 min/cont)
- Max torque: 199/146 N-m (5 min/cont)

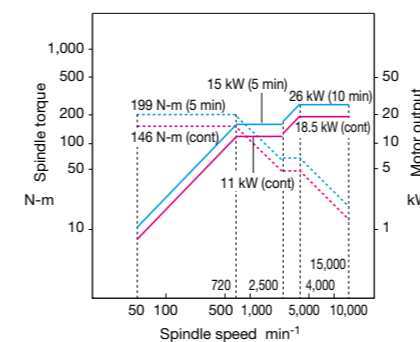

Die/mold and aluminum machining

High-speed spindle HSK-A63 only (option)

- Spindle speed: 20,000 min⁻¹
- Max output: 30/22 kW (10 min/cont)
- Max torque: 57/42 N-m (10 min/cont)

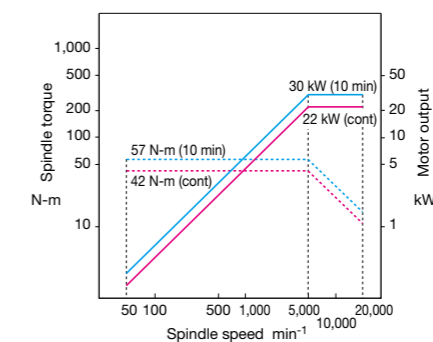

Higher floor space productivity with larger work envelope

Optimal travels for the large parts applications

The X-axis travel is longer and the maximum loadable workpiece size has also increased to handle a wider range of applications.

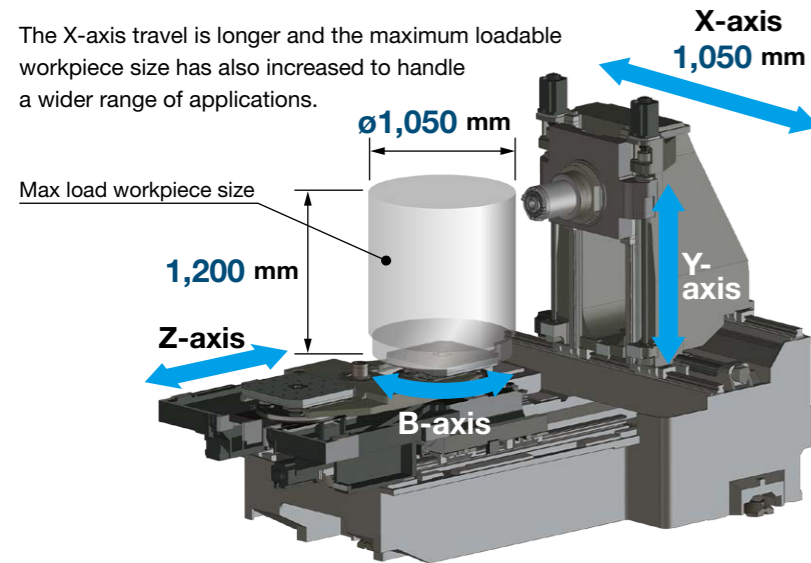

Work envelope

X-axis travel: **1,050 mm**
(longer than previous machine)
Y-axis travel: 900 mm
Z-axis travel: 1,000 mm

Max load workpiece size

ø1,050 × 1,200 mm^{*1, *2}
(larger than previous machine)
^{*1.} Standard 2-pallet APC only
^{*2.} From pallet top to 120 mm up, max workpiece diameter is ø1,000 mm

Max tool length

630 mm^{*3} (option)
(longer than previous machine)
^{*3.} Chain magazine only

Machine structurally designed for ease of use

Built for operator-friendly workability.

Good accessibility to the spindle and workpiece

- 800 mm from the operation panel to the spindle.



Operation panel mounted on the left Swivel movement improves visibility and workability

- Workpiece and operation screen XYZ directions are the same
- Operator can be close to the screen, for less fatigue



Photo shows a 19 inch operation panel (option)

Open ceiling for setup station and workspace area

- Easy part load/unload by crane
- Lighting is good, and coolant doesn't drip in the workspace area



Setup station



Workspace area

Outstanding dimensional stability even for long-run machining of large workpieces



Thermo-Friendly Concept

The unique approach of "accepting temperature changes."

Outstanding dimensional stability

Okuma's Thermo-Friendly Concept achieves high dimensional stability not only when the room temperature changes, but also at machine startups or when machining is resumed. To stabilize thermal deformation, warming-up time is shortened and the burden of dimensional correction during machining restart is reduced.

MA-600HIII Thermal deformation over time: 7 μm

(room temperature change: 8°C)

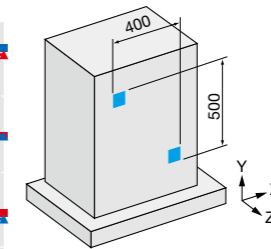
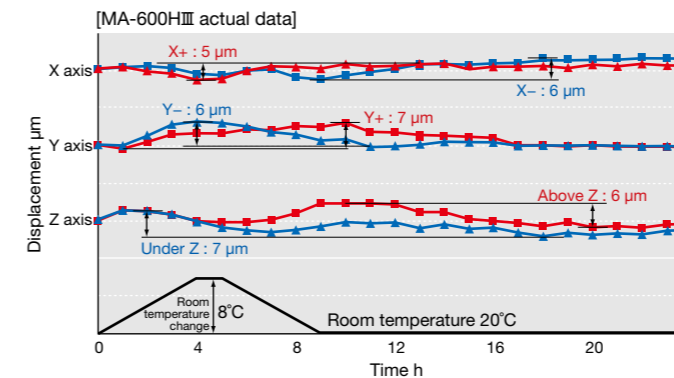

Measuring position X: 400 mm, Y: 500 mm
Coolant (with shower washing)

Note: The "actual data" referred to above for this brochure represent examples, and may not be obtained due to differences in specifications, tooling, cutting condition, and others.

■ **TAS-C** (option)
Thermo Active Stabilizer—Construction
Providing optimal control of the machine and stable machining accuracies even during ambient temperature changes.

■ **TAS-S** (option)
Thermo Active Stabilizer—Spindle
Spindle deformation will be accurately controlled even during operations with frequent speed changes.

Machine is structurally designed to achieve outstanding accuracy

Highly rigid 3-point supported bed

Easy installation thanks to bed that does not twist. Supporting stable, high accuracy over a long period.

Ball screw bracket

The ball screw brackets at both ends of the X-Y-Z axes are reinforced and combined for highly accurate drive and positioning.

Ball screw cooling

X-Y-Z axes ball screw cooling and Y-axis motor bracket cooling are standard. Assuring stable accuracy during high rates of operation.

Indexing table and pallet

Highly accurate indexing table

- Standard: Curvic coupling (1 degree indexing)
- Optional: NC (0.001 degree indexing)

The pallet seating on a tapered cone achieves highly accurate positioning and excellent durability.

The exactness of bi-directional positioning

(MA-600HIII AbsoScale actual data*)

- X-axis (travel: 1,050 mm) **1.9 μm**
- Y-axis (travel: 900 mm) **2.6 μm**
- Z-axis (travel: 1,000 mm) **1.8 μm**

Bi-directional repeatability

(MA-600HIII AbsoScale actual data*)

- X-axis (travel: 1,050 mm) **1.4 μm**
- Y-axis (travel: 900 mm) **1.2 μm**
- Z-axis (travel: 1,000 mm) **1.1 μm**

* The "actual data" referred to above represent examples of data obtained by using ISO 230-2 test methods done at Okuma factories, and they are not guaranteed values.

Productivity improved by shortening non-cutting time

Shorter tool change times are possible when using thru-spindle coolant

● Suction of excess coolant in spindle

Removes residual coolant in the tool and spindle in one draw: 0.4 seconds (drill actual data). In-spindle coolant suction eliminates the need for an air blow (minimum 15 seconds) to remove residual coolant, shortening tool change time.

Coolant suction time: 0.4 seconds^{*1}

^{*1}. Coolant suction time varies depending on the tool.

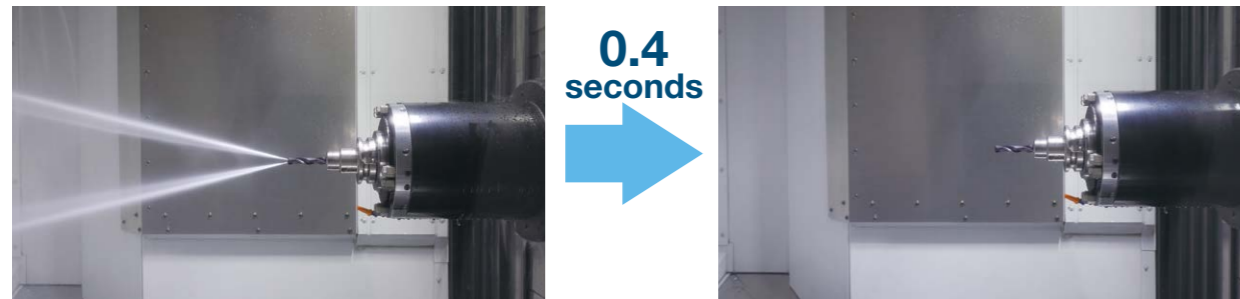

Shorter table indexing times

Table indexing time is shortened by the SERVO NAVI Rotary Axis Inertia Auto Setting function.

Table indexing time [1 degree indexing]
1.6 sec/90°^{*2} 20% reduction
 (compared to previous model)

Table indexing time [0.001 degree indexing]
1.4 sec/90°^{*2} 44% reduction
 (compared to previous model)

^{*2}. At low inertia

High speed operations

- Rapid traverse : 60 m/min (X-, Y-, Z-axis)
- Rapid acceleration : 0.7 G (max)
- Tool change : 2.0 sec (T-T)^{*3}
- : 3.7 sec (C-C)^{*3}
- : 3.7 sec (CTC min)^{*4}
- Pallet change time : 12 sec^{*3}
- : 13 sec^{*4}

^{*3}. MAS standard measurements (formerly JIS B 6013)

^{*4}. ISO 10791-9 (2001) (JIS B 6336-9) measurements

Chip discharge that maximizes uptime

With simple workspace covering and reinforced coolant applications, efficient chip discharge and long-run applications possible

Just Z-axis travel single cover and a smooth X-,Y-axis telescopic covers suppress chip accumulation.

Moreover, in dry machining without coolant, washing only the lower workspace area with coolant is possible.

In-machine washing prevents likely areas of chip accumulation, by cleaning away chips to maintain long-run production runs.

■ Chip discharge and workspace area designed to prevent chip accumulation

In-machine wash coolant: 450 L/min (18% improvement compared to previous machine)

Stronger workspace lower area wash and hinge conveyor smoothly removes large-volume coolant and accumulated chips out of the machine.

From the upper area of the workspace, a shower coolant system (option) and coolant from the X-,Y-axis telescopic covers suppress chip accumulation.



Preventing chip accumulation with smooth X-,Y-axis telescopic covers and Z-axis stainless steel single cover.

Flat covers in the workspace prevent chip accumulation

Center trough design enhances large amount of chip discharge out of the machine



Z-axis stainless steel single cover

X-,Y-axis telescopic covers

■ Out-of-machine chip discharge

Optional a lift-up chip conveyor that discharges chips to the outside of the machine, and a Sludgeless Tank (recommended option) that efficiently collects sludge are available.

Note: The Sludgeless Tank (recommended option) includes: a hinge + scraper (with drum filter) lift-up chip conveyor.



Lift-up chip conveyor

Sludgeless Tank

“Sludgeless Tank” enhances stable operations (recommended option)

Suppresses sludge accumulation in the coolant tank. Dramatically reducing troublesome tank cleaning work

It is important to remove impurities (sludge) contained in the coolant for stable operation of the machine, and coolant tank cleaning is indispensable. The Sludgeless Tank (recommended option) efficiently collects 99% of the amount of sludge and reduces coolant contaminants. By suppressing sludge accumulation in the tank, the frequency of troublesome tank cleaning can also be drastically reduced, enabling stable operations over long runs.

Coolant sludge removal, less environmental impact when disposing coolant

Sludge removal rate **99%^{*1}** (for castings)
97%^{*1} (for aluminum)

Note: · After tertiary filtration (bag filter) permeation
· Okuma evaluated removal rate

No tank cleaning required for two years
(Okuma equipment actual data)

Unidirectional coolant flow in the Sludgeless Tank also suppresses coolant deterioration due to stagnation. Coolant replacement frequency is greatly reduced, and the environmental impact is less when coolant disposal amounts are also reduced.

*1. Water-soluble coolants only.

Keeping spindle tapers clean

The three filtration devices in the Sludgeless Tank and coolant suction inside the spindle reduce dirt on the spindle taper and lessen defective machining.

Note: Suction of coolant from the spindle also limits the outflow of coolant to the spindle taper when changing tools.

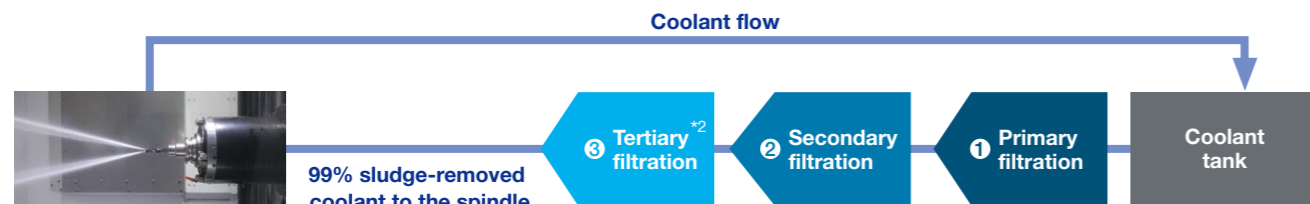

*2. Tertiary filtration available only with thru-spindle coolant specs.

Compact—integrated with the through-spindle coolant tank

The thru-spindle coolant tank is integrated, and the coolant heater/cooler (option) can be mounted on the tank, saving space.

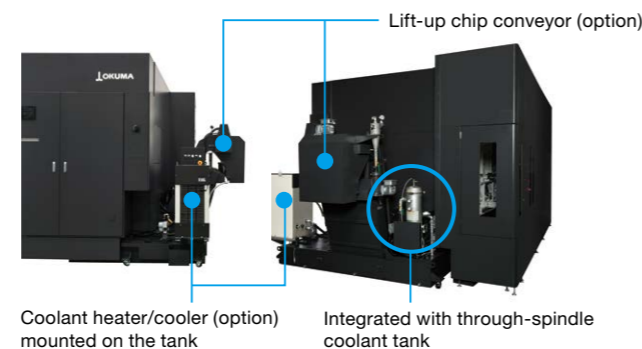

Automation support to further improve productivity

Flexible automation support

Equipped with a large number of thru-pallet fixture ports (option)

The setup station pallet base can be equipped with up to 16 fixture ports for hydraulic and pneumatic pressure, and the workspace area table base can have up to 8 ports for flexible automation applications. Hydraulic circuits that tend to be complicated can be simplified, and auto-clamp fixture designing becomes easy. Customers benefit from more freedom in systemizing and in meeting more diverse automation needs.

Setup station

Max 16 ports (hyd/pneu)^{*1, *2}



For the setup station

16 port preps

With 16 ports, arrangements for robotic and automation applications will be expanded, and more flexible fixture support will be possible. For example, with 16 ports, a large number of parts can be mounted, and a different workpiece can be clamped on each side of a 4-sided tooling block fixture.

*1. 8 or 16 ports available.
(for 16 ports, max 12 hydraulic ports)
*2. Hydraulic pressure: 7 MPa.



Workspace area (in machine)

Part load/unload^{*1}: Max 7 ports^{*3}
Workholding clamps^{*2}: Max 8 ports^{*3}

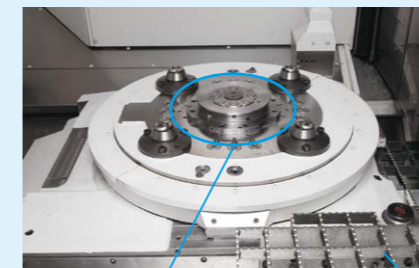

Part load/unload in workspace area (table) also possible

MA-600HIII “part load/unload” fixture ports also allow part load/unload in the workspace area in the machine. Adjustment times for trial cuts can be shortened and fixture readjustments in the workspace improve work efficiency. With more ports, hydraulic applications have increased, eliminating complicated hydraulic circuits arrangements.

*1. For part load/unload in the workspace area, **select part load/unload.**
*2. If the above is not required, **select workholding clamps.**
*3. Hydraulic pressure: 7 MPa.

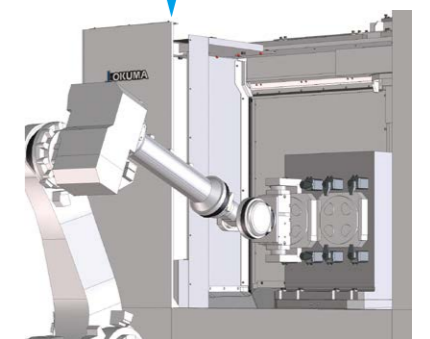

Auto Setup Station Pallet Rotate (option)

This feature automatically rotates the setup station pallet in 90° increments by stepping on the foot switch. Operator efficiency has been improved, and robotic part load/unload can be done from multiple fixtures.



Flexible production of large-variety workpiece applications

An impressive lineup of automation systems

Flexible APC systems*

Multi-pallet APCs allow the operator to single setup a large number of workpieces, and use the extra time available for other jobs. Setups at the end of the day for untended operations are also a benefit.

- Multi-pallet APC connects to standard 2-pallet rotary-shuttle APC
- Pallet change time is the same as in the standard APC
- Can be adapted to match plant layout and type of production

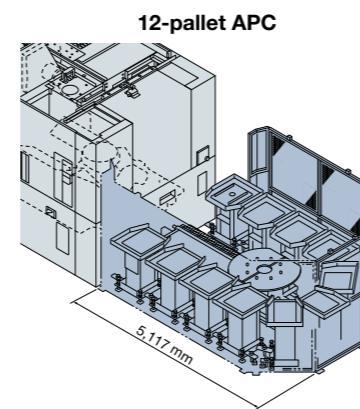
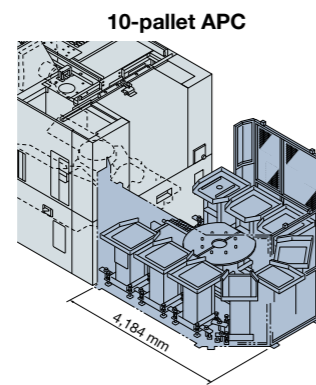
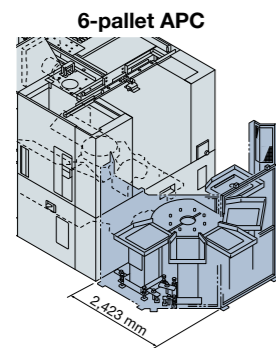

Multi-Pallet Tower APC*

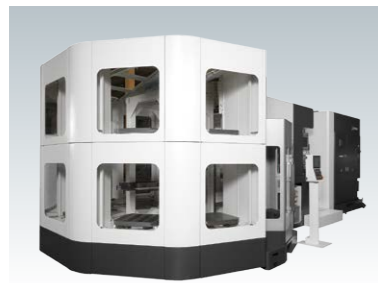

Tower 12P-APC system



Setup station

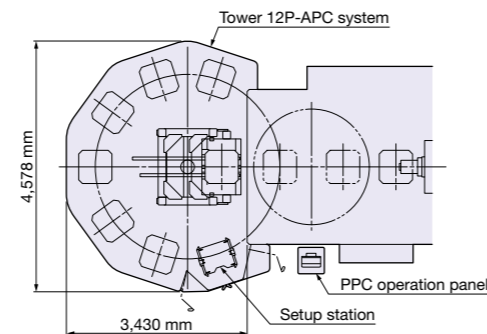

Auto tool changer

The standard number of tools that can be stored is 60. Flexible, high-volume tool storage systems available for adding more types of workpieces.

Matrix magazines store larger numbers in compact, quick tool-change arrangements.

- Matrix magazines: Tool preparation time Minimum: 12 seconds (multiple magazines: 19 seconds)

ATC magazine capacity	Magazine type	ATC tool			
		Max diameter		Maximum length, mass, moment	
		w/adjacent	w/o adjacent		
40 tools, 60 tools (standard)	Chain magazine	ø140 mm	ø240 mm	Max length 450 [630] mm	Max mass 25 kg Mass moment 36.75 N-m
81 tools, 111 tools, 141 tools, 171 tools	Matrix magazine (171 tool cabinet)	ø105 mm (standard)	ø240 mm (large size)	Max length 450 [600] mm	
195 tools, 225 tools, 255 tools, 285 tools	Matrix magazine (285 tool cabinet)	ø130 mm (mid-size)			
320 tools, 400 tools	Multiple magazine	ø135 mm	ø240 mm		



Matrix system ATC magazine (option)

*: The maximum workpiece dimensions are ø1,000 mm x 1,000 mm.

OSP suite OSP-P300MA

The Next-Generation Intelligent CNC

With revamped operation and responsiveness—ease of use for machine shops first!

Smart factories are using advanced digitization and networking (IIoT) in manufacturing to achieve enhanced productivity and added value. The OSP has evolved tremendously as a CNC suited to advanced intelligent technology. Okuma's new control uses the latest CPUs for a tremendous boost in operability, rendering performance, and processing speed. The OSP suite also features a full range of useful apps that could only come from a machine tool manufacturer, making smart manufacturing a reality.

Smooth, comfortable operation with the feeling of using a smartphone

Improved rendering performance and use of a multi-touch panel achieve intuitive graphical operation. Moving, enlarging, reducing, and rotating 3D models, as well as list views of tool data, programs, and other information can be accomplished through smooth, speedy operations with the same feel as using a smartphone. The screen display layout on the operation screen can also be changed to suit operator preferences and customized for the novice and/or veteran machinists.

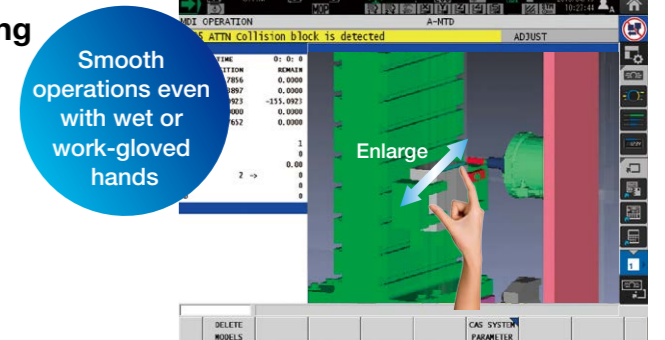

Note: 15 inch operation panel screen shots. Collision Avoidance System (option) shown above.

“Just what we wanted.”— Refreshed OSP suite apps

This became possible through the addition of Okuma's machining expertise based on requests we heard from real, machine-shop customers. The brain power packed into the CNC, built by a machine tool manufacturer, will “empower shop floor” management.



Maintenance Monitor

Routine inspection support

The Maintenance Monitor displays items for inspections before starting daily operation and regular inspections and the rough estimate of inspection timing. Touching the [INFO] button displays the PDF instruction manual file of relevant maintenance items.

NO.	ITEM	WORK	PROGRESS	REMAN	INFO	EXECUTE
310	Grease for tool changing unit (PDS)	Grease		5%	[INFO]	[EXECUTE]
311	Packing in tool changing unit (PDS)	Inspection		50%	[INFO]	[EXECUTE]
320	Brake control lubrication oil	Replace		100%	[INFO]	[EXECUTE]
411	Hydraulic unit oil	Replace		0%	[INFO]	[EXECUTE]
412	Hydraulic unit line filter	Cleaning		5%	[INFO]	[EXECUTE]
413	Hydraulic unit line filter	Replace		50%	[INFO]	[EXECUTE]
421	Oil for SPCD cooling unit	Replace		100%	[INFO]	[EXECUTE]

[INFO] button



Spindle Output Monitor

Increased productivity through visualization of motor power reserve



Turn-Cut Guide (option)

Making new machining technology simpler and easier to use

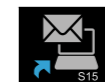

E-mail Notification

Monitoring operating status even when away from the machine

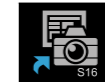

Screen Capture

Automatic saving of recorded alarms



Scheduled Program Editor

Easy programming without keying in code

Connect Plan Get Connected, Get Started, and Get Innovative with Okuma “Monozukuri”

Connect, Visualize, Improve

Okuma's Connect Plan is a system that provides analytics for improved utilization by connecting machine tools and visual control of factory operation results and machining records. Simply connect the OSP and a PC and install Connect Plan on the PC to see the machine operation status from the shop floor, from an office, from anywhere. The Connect Plan is an ideal solution for customers trying to raise their machine utilization.

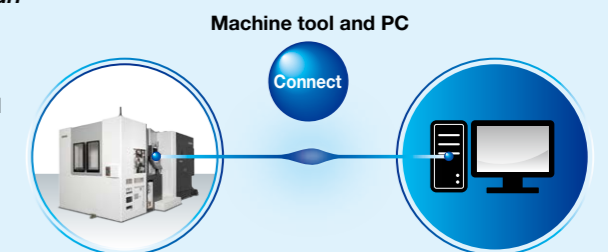

Advanced technology—effective for machine shops

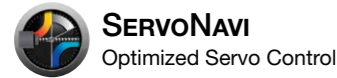

SERVO NAVI
Optimized Servo Control

Achieves long term accuracy and surface quality

■ SERVO NAVI AI (Automatic Identification)

● Work Weight Auto Setting

Cycle time shortened with faster acceleration
On table travel type machining centers, the table feed acceleration with the previous system was the same regardless of weight, such as workpieces and fixtures loaded on the table.

Work Weight Auto Setting estimates the weight of the workpiece and fixture on the table and automatically sets the linear axis servo parameters, including acceleration, to the optimum values. Cycle times are shortened with no changes to machining accuracy.

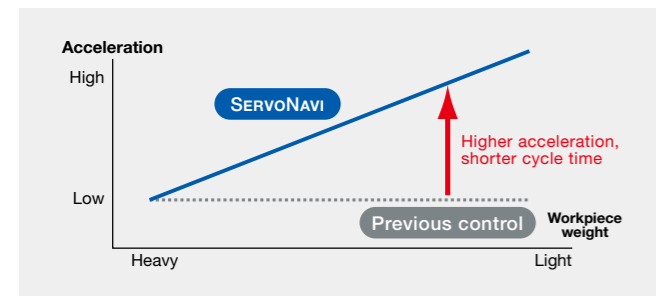

● Rotary Axis Inertia Auto Setting

Maintains high accuracy and stable movements
Depending on the workpiece or fixtures, inertia will vary, and with each variation the rotary axis positioning error in some cases became much larger.

Rotary Axis Inertia Auto Setting is able to estimate inertia from workpiece/fixture acceleration and deceleration, and automatically set the optimum the rotary axis servo parameters to maintain highly accurate and stable machine movements.

■ SERVO NAVI SF (Surface Fine-tuning)

● Reversal Spike Auto Adjustment

Maintains machining accuracy and surface quality
Slide resistance changes with length of time machine tools are utilized, and discrepancies occur with the servo parameters that were the best when the machine was first installed. This may produce crease marks at motion reversals and affect machining accuracy (part surface quality).

Reversal Spike Auto Adjustment maintains machining accuracy by switching servo parameters to the optimum values matched to changes in slide resistance.

● Vibration Auto Adjustment

Contributes to longer machine life
When aging changes machine performance, noise, vibration, crease marks, or fish scales may appear.

Vibration Auto Adjustment can quickly eliminate noise and vibration even from machines with years of operation.



Collision Avoidance System (option)
Collision prevention

Allowing operators to focus on making parts

■ World's first "Collision-Free Machine"

CAS prevents collisions in automatic or manual mode, providing risk-free protection for the machine and great confidence for the operator.

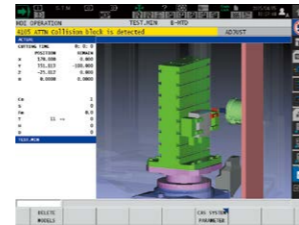

Machining Navi M-i, M-gII+ (option)
Cutting condition search for milling

Longer tool life and shorter machining times by optimizing cutting conditions

■ Searches for the best cutting conditions

- Machining Navi M-i changes automatically to optimum spindle speed
- Machining Navi M-gII+ displays several spindle speed possibilities

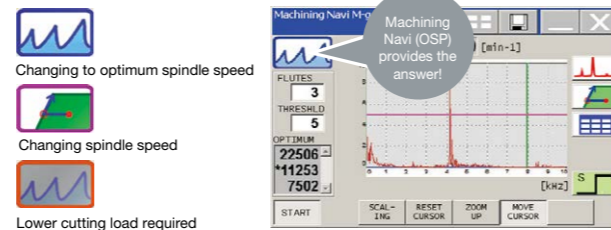

ECO suite
Next-Generation Energy-Saving System

A suite of energy saving applications for machine tools

■ ECO Idling Stop

Accuracy ensured, cooler off

Intelligent energy-saving function with the Thermo-Friendly Concept. The machine itself determines whether or not cooling is needed and cooler idling is stopped with no loss to accuracy. (Idling Stop included in a spindle cooler is standard for TAS-S equipped machines.)

Electricity consumption during non-machining time greatly reduced with "ECO Idling Stop", which shuts down each piece of auxiliary equipment not in use.

■ ECO Power Monitor

On-the-spot check of energy savings

Power is shown individually for spindle, feed axes, and auxiliaries on the OSP operation screen. The energy-saving benefits from auxiliary equipment stopped with ECO Idling Stop can be confirmed on the spot.

■ ECO Operation

(option)
Intermittent/continuous operation of chip conveyor and mist collector during operation

■ ECO Hydraulics

(option)
Energy-saving hydraulic unit using servo control technology

Hyper-Surface (option)
Auto machining data compensation

■ Further improvement of machined surface quality with new machining data compensation

By suppressing streaks and edge irregularities caused by CAM machining data, hand finish polishing time can also be reduced. In addition to the Sculptured-Surface Adaptive Acceleration Control with the previous Super-NURBS, the new Hyper-Surface function automatically compensates for edge positioning errors of the machining data output from CAM or the adjacent cutting path while maintaining shape accuracy.

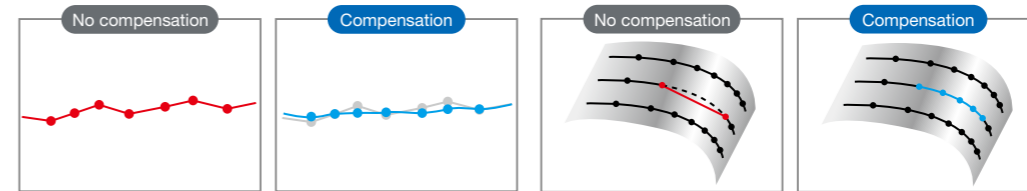

Smooths minor fluctuations and variations in command points Adjust steps errors between adjacent cutter paths



Comparison of machined surface quality

■ Turn-Cut

(option)

■ Shorter lead times with process-intensive machining

Simultaneously controlling X-Y circular motion with the tool edge position rotated by the spindle tool enables lathe-like turning.

- Tapers also possible
- Hole making with different diameters — with one tool
- Machine IDs/ODs with ATC-oversized large tool diameters

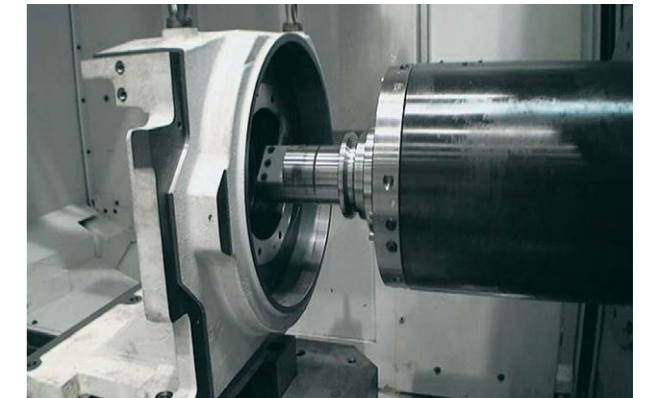
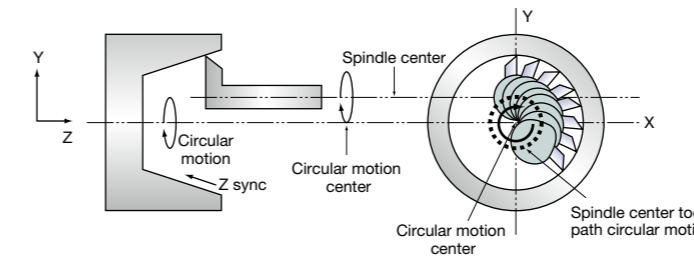

AI Machine Diagnosis (option)
Machine tool diagnostics technology with artificial intelligence (AI)

■ With predictive maintenance, prevent machine stoppages just in time

Okuma's AI-equipped control diagnoses the presence or absence of abnormalities in the machine spindle and feed axes and identifies any irregularities found.

Downtime from machine stoppage is minimized, so the benefits are highly accurate, productive, and stable operations over the long term. The operators themselves can easily diagnose the machine by following simple screen guidelines on the Okuma control.

- Notes:
1. AI diagnostic models are already installed, and diagnoses can be performed by the machine itself. AI diagnostic models can be updated through Okuma's Connect Plan.
 2. AbsoScale specs are required to diagnose ball screw failures.

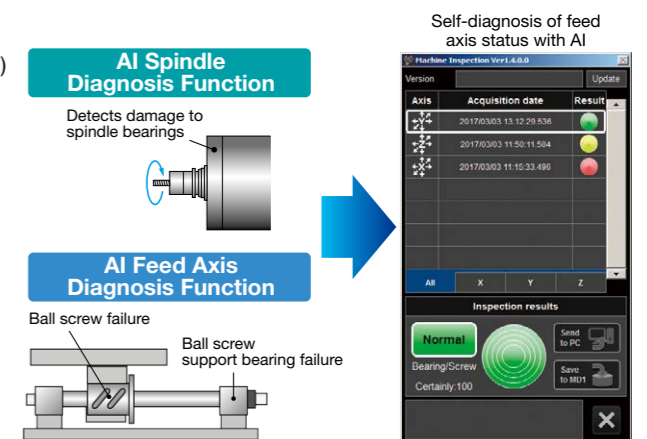

Machine Specifications

		MA-600HIII			
Item		Unit	No. 50	No. 40 ^{*1}	
Travels	X-axis (column left/right)	mm (in)	1,050 (41.34)		
	Y-axis (spindle up/down)	mm (in)	900 (35.43)		
	Z-axis (table front/back)	mm (in)	1,000 (39.37)		
	Spindle center to pallet top	mm (in)	50 to 950 (1.97 to 37.40)		
	Spindle nose to pallet center	mm (in)	70 to 1,070 (2.76 to 42.13)		
Pallet	Work area	mm (in)	630 × 630 (24.80 × 24.80)		
	Max load capacity	kg	1,200 [1,400]		
	Indexing angle	deg	1 [0.001]		
	Max workpiece dimensions ^{*2}	mm (in)	ø1,050 × 1,200 (ø41.34 × 47.24)		
Spindle	Speed	min ⁻¹	50 to 6,000 [50 to 6,000 (high-torque spindle), 50 to 10,000, 50 to 12,000]	50 to 15,000, 50 to 20,000	
	Tapered bore		7/24 taper No. 50 [HSK-A100]	7/24 taper No. 40 HSK-A63	
	Bearing dia	mm (in)	ø100 (ø3.94)	ø70 (ø2.76)	
Feed rate	Rapid traverse	m/min (ipm)	X, Y, Z: 60 (2,362)		
	Cutting feed rate	mm/min (ipm)	X, Y, Z: 1 to 60,000 (0.04 to 2,362)		
Motors	Spindle (10 min/cont) ^{*3}	kW (hp)	30/22 [45/37 ^{*3} , 45/30 ^{*3} , 45/30] (40/30 [60/50, 60/40, 60/40])	26/18.5 (35/25), 30/22 (40/30)	
	Feed axes	kW (hp)	X: 4.6 (6.13), Y: 4.6 (6.13) × 2, Z: 5.2 (6.93)		
	Table indexing	kW (hp)	3.5 (4.67)		
ATC	Tool shank		MAS403 BT50 [HSK-A100]	MAS403 BT40 HSK-A63 ^{*4}	
	Pull stud		MAS 2 [-]		
	Magazine capacity	tools	60 [40, 81, 111, 141, 171, 195, 225, 255, 285, 320, 400]		
	Max tool dia (w/ adjacent) ^{*5}	mm (in)	ø140 (5.51)	ø100 (3.94)	
	Max tool dia (w/o adjacent) ^{*5}	mm (in)	ø240 (9.45)	ø150 (5.91)	
	Max tool length	mm (in)	450 (17.72) [600 ^{*6} , 630 ^{*7} (23.62, 24.80)]		
	Max tool mass	kg (lb)	25 (55)	10 (22)	
	Tool selection		Memory random [Matrix magazines use fixed addresses]		
	Machine size	Height	mm (in)	3,174 (124.96)	
		Floor space; width × depth	mm (in)	3,435 × 7,068 (135.24 × 278.27) ^{*8}	
Mass		kg (lb)	25,000 (55,000) ^{*9}		
Controller		OSP-P300MA			

[]: Option *1. No. 40 spindle is option. *2. Standard 2-pallet APC. Multi-pallet APC and FMS: ø1,000 × 1,000 mm, hydraulic fixtures (link): ø1,000 × 900 mm. *3. High-torque spindle (heavy-duty cutting) and 10,000 min⁻¹ spindle rating: 20 min/cont. *4. 20,000 min⁻¹ with HSK-A100 only. *5. Values differ with a matrix magazine. Please inquire. *6. Matrix and multiple magazines. *7. Chain magazines. *8. Off-machine chip discharge; hinge + scraper with drum filter (Recommended). *9. Workpieces and tools not included.

Standard Specifications

Spindle speed	6,000 min ⁻¹ (30/22 kW [10 min/cont])	APC fork washer	
ATC magazine capacity	60 tools	Air filter and oiler	
Spindlehead cooling system		Telescopic cover	
Simple ball screw cooler	X-Y-Z axes	Hydraulic unit	
Centralized lubrication	Oil level alarm and pressure alarm	Automatic 1° indexing table	
Coolant supply system	Tank: 1,144 L (Dirty tank: 1,018 L (effective: 696 L) Clean tank: 126 L) Pump: 3.0 kW, 1.5 kW, 0.55 kW (50 Hz)/0.75 kW (60 Hz)	2-pallet rotary-shuttle APC	Pallet top surface M16 tap
		Full enclosure shielding	2-pallet pivoted type for APC
		Operation panel	15 inch
		ATC operation panel	For manual operation
In-machine chip discharge	Hinge	Work lamp	LED
Chip pan for above		Status indicator	3 phase C type
Thru-spindle coolant*	1.5 MPa	Foundation washers, jack bolts	
Suction of excess coolant in spindle		Slip stoppers and chemical anchors	
ATC air blower (blast)		Tool release lever	
Chip air blower (blast)	Nozzle type	Tapered bore cleaning bar	
Coil conveyor under APC		Hand tools	
In-machine chip washer		Tool box	

*: Okuma pull stud required with thru-spindle coolant.

Optional Specifications



Spindle speeds	50 to 10,000 min ⁻¹ , 45/30 kW, No. 50	Chip air blower (blast)	Adapter
	50 to 12,000 min ⁻¹ , 45/30 kW, No. 50	Coolant system	Sludgeless Tank (recommended option)
	50 to 15,000 min ⁻¹ , 26/18.5 kW, No. 40	Off-machine chip discharge (lift-up chip conveyor types)	Refer to Recommended chip conveyors.
	50 to 20,000 min ⁻¹ , 30/22 kW, HSK-A63 only		
High-torque spindle	6,000 min ⁻¹ , 45/37 kW, 1,071 N-m, No. 50	Chip bucket for above	Height 700 mm, 1,000 mm
Dual contact spindle	HSK, BIG-PLUS®	Hydraulic oil cooler	
ATC magazine capacity (tools)	40 tools (chain magazine type)	Coolant heater / cooler	
	81, 111, 141, 171, 195, 225, 255, 285 tools (matrix magazine type)	Auto tool length comp/ breakage detection	Touch sensor
	320, 400 tools (multiple magazine system)	Auto zero offset/auto gauging	Touch probe
AbsoScale detection	X-Y-Z axes, X-Y axes	Tool life management	By hour meter
Auto 0.001° indexing table	Built-in NC table	Turn-Cut	AbsoScale detection and ball screw cooling required.
APC	Parallel shuttle: 6P, 10P, 12P	Pull stud bolt shape	MAS-1, CAT, DIN, JIS
Auto pallet changer	Tower: 12P	Pull stud bolt	MAS-1, MAS-2, CAT, DIN, JIS
FMS 2-pallet APC	Wing block type, Under-pallet fork type	2-sided tooling block	Height: 850/825 mm, Pitch: 100/125 mm
Pallet top surface configuration	T-slot	4-sided tooling block	Height: 850/825 mm, Pitch: 100/125mm
Spare pallets		Ball screw cooler	X-Y-Z axes
Edge locator		Recommended for die machining	AbsoScale detection (X-Y-Z axes) Hyper-Surface DNC-DT, 0.1 µm control
Oil-hole coolant system	1.5 MPa		
Thru-spindle coolant*	7.0 MPa, large flow 1.5 MPa, large flow 7.0 MPa		
Shower coolant	10 nozzles	TAS-S	Thermo Active Stabilizer—Spindle
Work wash gun		TAS-C	Thermo Active Stabilizer—Construction
Oil mist lubricator			

* Okuma pull stud required with thru-spindle coolant.

Chip conveyors

(Please contact an Okuma sales representative for details.)

○: Recommended
△: Conditionally recommended

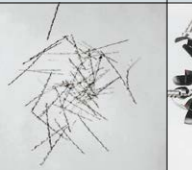
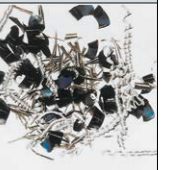
Workpiece Material	Steel	Cast iron	Aluminum/ non-ferrous metal	Mixed (general use)
Chip shape				
In-machine chip discharge	○	○	○	○
Off-machine chip discharge (option) ^{*4}	Hinge type (standard) ^{*1}	○	○	○
	Hinge + scraper with drum filter ^{*2} (recommended)	○	○	○
	Hinge type	○	—	—
	Scraper type ^{*3}	—	○ (dry)	—
Scraper type with drum filter ^{*3}	—	○ (wet) with magnet	△	—

*1. Scraper type (option) also available. *2. Included when Sludgeless Tank is selected. *3. When chips are shorter than 100 mm

*4. With limitations per conveyor discharge direction.

Off-machine lift-up chip conveyors

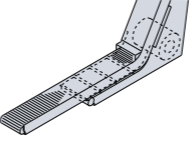
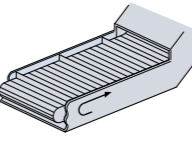
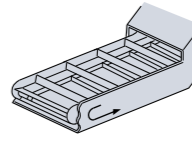
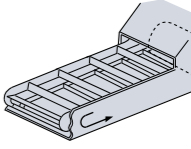
Type	Hinge + scraper with drum filter	Hinge	Scraper	Scraper with drum filter
Shape				

Standard Specifications

Basic Specs	Control	X, Y, Z, simultaneous 3 axis, spindle control (1 axis)
	Position feedback	OSP full range absolute position feedback (zero point return not required)
	Coordinate functions	Machine coordinate system (1 set), work coordinate system (20 sets)
	Min / Max command	±99999.999 mm, ±9999.9999° 8-digit decimal, command units: 0.001mm, 0.01mm, 1mm, 0.0001°, 0.001°, 1°
	Feed	Cutting feed override 0 to 200%, rapid traverse override 0 to 100%
	Spindle control	Direct spindle speed commands, override 30 to 300%, multi-point indexing
	Tool compensation	No. of registered tools: Max 999 sets, tool length/radius compensation: 3 sets per tool
	Display	15-inch color LCD + multi-touch panel operations
	Self-diagnostics	Automatic diagnostics and display of program, operation, machine, and NC system faults
	Programming	Program capacity
Program operations		Program management, editing, scheduled program, fixed cycle, G-/M-code macros, arithmetic, logic statements, math functions, variables, branch commands, coordinate calculate, area machining, coordinate convert, programming help
Operations	"suite apps"	Applications to graphically visualize and digitize information needed on the shop floor
	"suite operation"	Highly reliable touch panel suited to shop floors. One-touch access to suite apps.
	Easy Operation	"Single-mode operation" to complete a series of operations, advanced operation panel/graphics facilitate smooth machine control
	Machine operations	MDI, manual (rapid traverse, manual cutting feed, pulse handle), load meter, operation help, alarm help, sequence return, manual interrupt/auto return, pulse handle overlap, parameter I/O, PLC monitor, easy setting of cycle time reduction
	MacMan	Machining management: machining results, machine utilization, fault data compile & report, external output
Communications / Networking		USB (2 ports), Ethernet, DNC-T1
High speed/accuracy specs		Hi-G Control, Hi-Cut Pro, pitch error compensation, SERVO NAVI, Machining Time Shortening Function
Energy-saving	ECO suite	ECO Idling Stop, ECO Power Monitor ¹

¹. The power display shows estimated values. When precise electrical values are needed, select the on-machine wattmeter option.

Optional Specifications

Item	Kit Specs	NML		3D		AOT	
		E	D	E	D	E	D
Interactive functions							
Advanced One-Touch IGF-M (Real 3D simulation included)						●	●
Interactive MAP (I-MAP)				●	●		
Programming							
Operation buffer 10MB							
Auto scheduled program update		●	●	●	●	●	●
Additional G/M-code macros							
Common variables	1,000 pcs						
(Std: 200 pcs)	2,000 pcs						
Program branch; 2 sets							
Program notes (MSG)			●	●	●	●	●
Coordinate system selection	100 sets	●	●	●	●	●	●
(Std: 20 sets)	200 sets						
	400 sets						
Helical cutting (within 360°)		●	●	●	●	●	●
3D circular interpolation		●	●	●	●	●	●
Synchronized Tapping II		●	●	●	●	●	●
Arbitrary angle chamfering		●	●	●	●	●	●
Cylindrical side facing		●	●	●	●	●	●
Slope machining		●	●	●	●	●	●
Tool grooving (flat-tool free-shaped grooving)							
Turn-Cut							
Tool max rotational speed setting							
F1-digit feed	4 sets, 8 sets, parameter						
Programmable travel limits (G22, G23)		●	●	●	●	●	●
Skip (G31)							
Axis naming (G14)							
3D tool compensation							
Tool wear compensation		●	●	●	●	●	●
Drawing conversion	Programmable mirror image (G62)						
	Enlarge/reduce (G50, G51)	●	●	●	●	●	●
User task 2	I/O variables (16 each)						
Tape conversion*							
Monitoring							
Real 3D Simulation				●	●	●	●
Simple load monitor	Spindle overload monitor	●	●	●	●	●	●
NC operation monitor	Hour meter, work counter	●	●	●	●	●	●
Hour meters	Power, spindle, NC, cutting						
Operation end buzzer	With M02, M30, and END commands						
Work counter	With M02 and M30 commands						
MOP-TOOL	Adaptive control, overload monitor						
AI Machine Diagnosis Function	Spindle, feed axes / Spindle						
Machine Status Logger							
Cutting Status Monitor							
Tool life management	Hour meter, No. of workpieces	●	●	●	●	●	●
Gauging							
Auto gauging	Touch probe (G31)						
Auto zero offset	Includes auto gauging						
Tool breakage detection	Touch sensor (G31)						
	Includes auto tool offset						
Manual gauging (w/o sensor)		●	●	●	●	●	●
Interactive gauging (touch sensor, touch probe required)		●	●	●	●	●	●

Item	Kit Specs	NML		3D		AOT	
		E	D	E	D	E	D
External I/O communication							
RS-232C connector							
DNC-T3							
DNC-B (RS-232C-Ethernet transducer used on OSP side)							
DNC-DT							
DNC-C/Ethernet							
Additional USB (Additional 2 ports, Std: 2 ports)							
Automation / untended operation							
Auto power shut-off	M02 and END alarms, work preps done → OFF	●	●	●	●	●	●
Warm-up (calendar timer)							
External program selection	Button, rotary switch, digital switch, BCD (2-digit, 4-digit)						
Cycle time reduction (Ignores certain commands)		●	●	●	●	●	●
Pallet pool control (PPC) (Required for multi-pallet APC)							
Robot, loader I/F							
High-speed, high-precision							
AbsoScale detection	X-Y-Z axes						
Inductosyn detection	Additional axes						
Hyper-Surface ^{*1}	X-Y-Z axes only						
Super-NURBS ^{*2,*3}	X-Y-Z, B axes (up to 2)						
0.1 μm control (linear axis commands)							
TAS-S (Thermo Active Stabilizer—Spindle)							
TAS-C (Thermo Active Stabilizer—Construction)							
ECO suite (energy saving functions)							
ECO Operation							
ECO Power Monitor	Wattmeter						
Energy-saving	Inverter						
hydraulic unit	ECO Hydraulics						
Other							
CNC cabinet lamp							
Circuit breaker							
Sequence operation	Sequence stop	●	●	●	●	●	●
Upgraded sequence restart	Mid-block return			●	●		
Pulse handles	2 pcs, 3 pcs (Std: 1 pc)						
External M codes	4 sets, 8 sets						
Collision Avoidance System ^{*1,*2}							
Machining Navi M-i, M-gII+ (cutting condition search)							
One-Touch Spreadsheet							
Block skip; 3 sets							
Additional axes	A-, B-, C-axis [preps, specs]						
Fixture offset							
OSP-VPS (Virus Protection System)							
19 inch display operation panel w/ adjustable-tilt key board							

Note 1. NML: Normal, 3D: Real 3D Simulation, AOT: Advanced One-Touch IGF-M,

E: Economy, D: Deluxe

Note 2. ★ Technical consultation needed for specifications

*1. There are limitations when Hyper-Surface and Collision Avoidance System are used simultaneously.

*2. There are limitations when Super-NURBS and Collision Avoidance System are used simultaneously.

*3. Select Super-NURBS for simultaneous linear and rotational axis machining.

Working range

Unit: mm

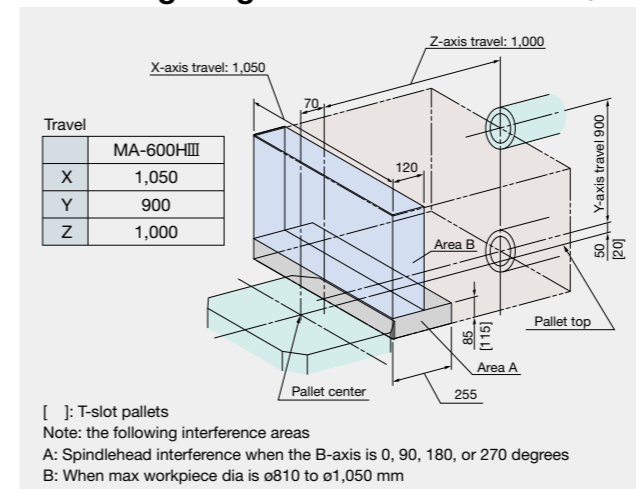

Maximum workpiece dimensions

Unit: mm

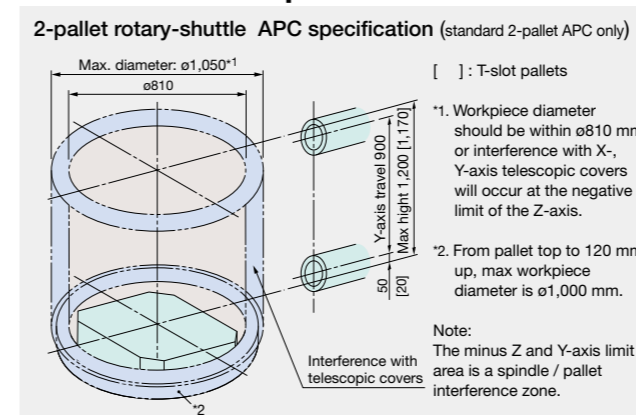

Pallet dimensions

Unit: mm

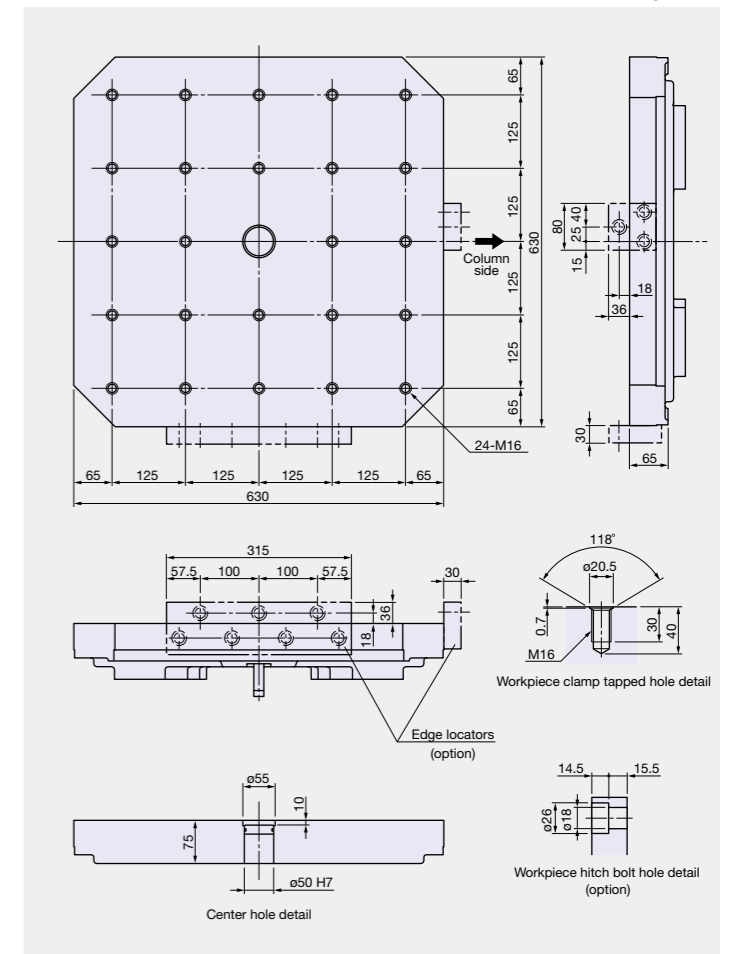

MA-600III Dimensional/Installation Drawings

Unit: mm

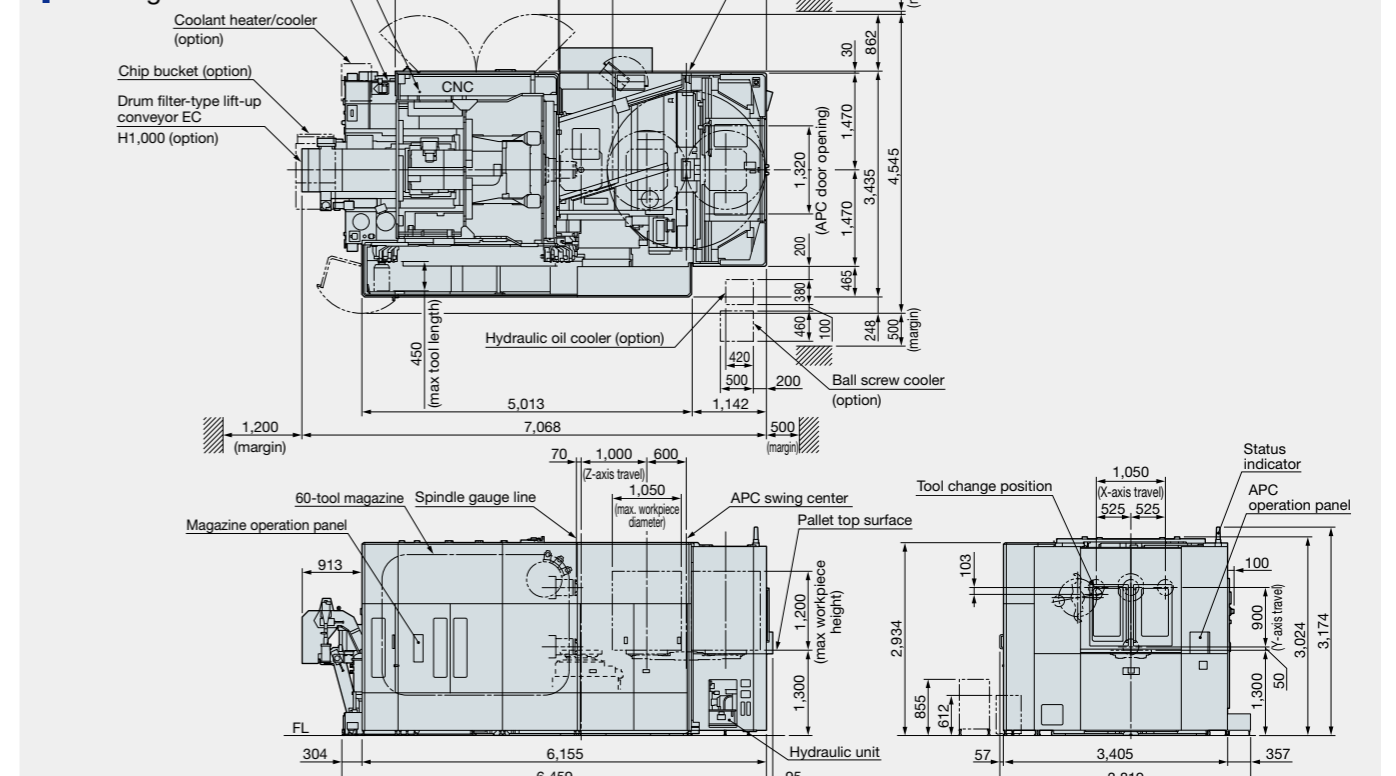

When using Okuma products, always read the safety precautions mentioned in the instruction manual and attached to the product.

● The specifications, illustrations, and descriptions in this brochure vary in different markets and are subject to change without notice.
Pub.No MA-600H3-E-(2a)-300 (Jul 2021)

This product is subject to the Japanese government Foreign Exchange and Foreign Trade Control Act with regard to security controlled items; whereby Okuma Corporation should be notified prior to its shipment to another country.



OKUMA Corporation

Oguchi-cho, Niwa-gun,
Aichi 480-0193, Japan
TEL: +81-587-95-7825 FAX: +81-587-95-6074